

Technical Manual  
**WATER SOFTENER**



**SPECTRUM ELITE**

## TABLE OF CONTENT

Table of content.....	Page 2
Warning & Safety instructions.....	Page 3
Operating conditions & Requirements .....	Page 4
Installation .....	Page 5
Commissioning.....	Page 6
Electronic control panel .....	Page 7
Maintenance.....	Page 10
Hydraulic flow diagrams.....	Page 12
Troubleshooting.....	Page 13
Electrical wiring diagram .....	Page 15
Exploded view - Valve body assembly .....	Page 16
Exploded view - Valve head assembly .....	Page 18
Technical data.....	Page 18
Warranty.....	Page 19
Reporting Bugs.....	Page 21
Operating Conditions & Requirements.....	Page 22
Electronic Control Panel.....	Page 23
Erie Connect™ App.....	Page 24

## WARNING & SAFETY INSTRUCTIONS

- Before you begin the installation of the appliance, we advise you read and carefully follow the instructions contained in this manual. It contains important information about safety, installation, use and maintenance of the product. The actual system that you have received, may differ from the pictures/illustrations/descriptions in this Technical Manual.
- Failure to follow the instructions could cause personal injury or damage to the appliance or property. Only when installed, commissioned and serviced correctly, the appliance will offer you many years of trouble-free operation.
- The appliance is intended to 'soften' the water, meaning it will remove hardness minerals; it will not necessarily remove other contaminants present in the water. The appliance will not purify polluted water or make it safe to drink!
- Installation of the appliance should only be undertaken by a competent person, aware of the local codes in force. All plumbing and electrical connections must be done in accordance with local codes.
- Before setting up the appliance, make sure to check it for any externally visible damage; do not install or use when damaged.
- Use a hand truck to transport the appliance. To prevent accident or injury, do not hoist the appliance over your shoulder. Do not lay the appliance on its side.
- Keep this Technical Manual in a safe place and ensure that new users are familiar with the content.
- The appliance is designed and manufactured in accordance with current safety requirements and regulations. Incorrect repairs can result in unforeseen danger for the user, for which the manufacturer cannot be held responsible. Therefore repairs should only be undertaken by a competent technician, familiar and trained for this product.
- In respect of the environment, the appliance should be disposed of in accordance with Waste Electrical and Electronic Equipment requirements. Refer to national/local laws and codes for correct recycling of the appliance.

## OPERATING CONDITIONS & REQUIREMENTS

- **OPERATING PRESSURE MIN-MAX: 1,4-8,3 bar / 20-120 psi**
  - this appliance is configured to perform optimally at an operating pressure of 3 bar (45 psi)  $\pm\frac{1}{2}$  bar (7 psi); in case of a lower or higher operating pressure the performance may be affected negatively!
  - check water pressure regularly; it may fluctuate severely depending on the time of day, the day of the week or even the season of the year.
  - take into account that night time water pressure may be considerably higher than day time water pressure.
  - install a pressure reducer ahead of the appliance if necessary.
  - install a pressure booster, if it is likely that water pressure may drop below the minimum.
  
- **OPERATING TEMPERATURE MIN-MAX: 2-48 °C / 35-120 °F**
  - do not install the appliance in an environment where high ambient temperatures (e.g. unvented boiler house) or freezing temperatures can occur.
  - the appliance cannot be exposed to outdoor elements, such as direct sunlight or atmospheric precipitation.
  - do not install the appliance too close to a water heater; keep at least 3 m (10 ft) of piping between the outlet of the appliance and the inlet of the water heater; water heaters can sometimes transmit heat back down the cold pipe into the appliance; always install a check valve at the outlet of the appliance.
  
- **ELECTRICAL CONNECTION:**
  - the appliance only works on 24VDC; always use it in combination with the supplied transformer.
  - make sure to plug the transformer into a power outlet, which is installed in a dry location, with the proper rating and over-current protection.

# INSTALLATION

## INLET & OUTLET

☑ In case of high concentration of impurities in the inlet water, we recommend the installation of a sediment filter, ahead of the appliance.

☑ If the appliance is not equipped with the included factory bypass, we strongly recommend to install a 3-valve bypass system (not included with this product!) to isolate the appliance from the water distribution system in case of repairs. It allows to turn off the water to the appliance, while maintaining (untreated) water supply to the user.

### WITH FACTORY BYPASS

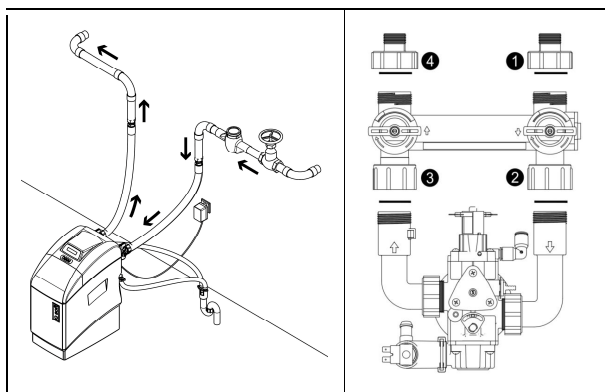

❶ = mains water supply (untreated water)

❷ = inlet of appliance (untreated water)

❸ = outlet of appliance (treated water)

❹ = house/application (treated water)

1. Screw the factory bypass onto the elbow connections of the appliance (❷&❸); make sure to install the gasket seals. Tighten the nuts firmly by hand.
2. Screw the connection kit with nuts onto the factory bypass (❶&❹); make sure to install the gasket seals. Tighten the nuts firmly by hand.
3. Connect the mains water supply to the adaptor on the inlet port of the factory bypass (❶).
4. Connect the house/application to the adaptor on the outlet port of the factory bypass (❹).

### WITH 3-VALVE BYPASS SYSTEM (not included)

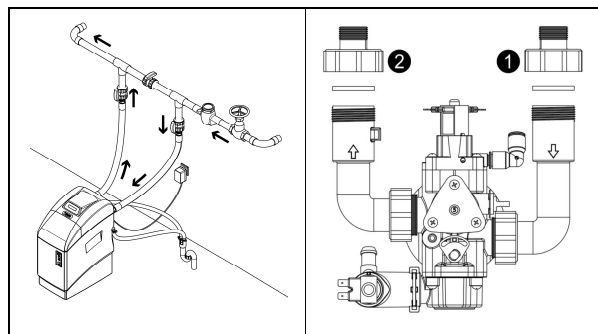

❶ = inlet of appliance (untreated water)

❷ = outlet of appliance (treated water)

1. Install the 3-valve bypass system.
2. Screw the connection kit with nuts onto the elbow connections of the appliance (❶&❷); make sure to install the gasket seals. Tighten the nuts firmly by hand.
3. Connect the 3-valve bypass system to the adaptors on the in (❶) and out (❷) elbow connections
4. Connect the mains water supply to the inlet of the 3-valve bypass system.
5. Connect the house/application to the outlet of the 3-valve bypass system.

## DRAIN

☑ To prevent backflow from the sewerage system into the appliance, always install and use the included drain adaptor with air gap and double hose barb, to connect the drain hoses to the sewerage system.

☑ Always use separate drain hoses for the control valve (discharge of rinse water) and the brine cabinet's overflow.

☑ Lay-out the drain hoses in such a way that pressure loss is minimized; avoid kinks and unnecessary elevations.

☑ Make sure that the sewerage system is suitable for the rinse water flow rate of the appliance.

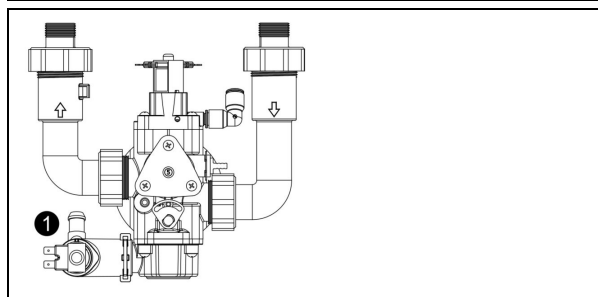

1. Install the drain adaptor with air gap to the sewerage system.
2. Connect a 1/2" hose to the drain solenoid of the control valve (❶); secure it by means of a clamp.
3. Run the drain hose to the drain adaptor, connect it and secure it by means of a clamp if necessary. This drain line operates under pressure, so it may be installed higher than the appliance.
4. Connect a 1/2" hose to the brine/salt tank overflow elbow; secure it by means of a clamp.
5. Run the drain hose to the floor drain; secure it by means of a clamp or zip tie. This drain line does NOT operate under pressure, so it may NOT be installed higher than the appliance.

# COMMISSIONING

## ELECTRICAL

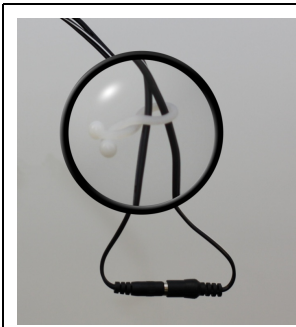

1. Plug the transformers output lead into the socket on the appliances power cord; secure it by means of the TwistLock clamp.
2. Plug the transformer into an electrical outlet.

## PRESSURIZING

1. Make sure the bypass system is in 'bypass' position.
2. Make sure the electronic controller of the appliance is in service mode.
3. Open the main water supply.
4. Open a cold treated water faucet nearby the appliance and let the water run for a few minutes until all air is purged and all foreign material that may have resulted from the installation is washed out; close the tap.
5. Gently pressurize the appliance, by putting it into service:
  - *factory bypass:*
    1. open the 'outlet' valve;
    2. slowly open the 'inlet' valve.
  - *3-valve bypass:*
    1. close the 'bypass' valve;
    2. open the 'outlet' valve;
    3. slowly open the 'inlet' valve.
6. After 2-3 minutes, open a cold treated water faucet nearby the appliance and let the water run for a few minutes until all air is purged from the installation and the resin bed is rinsed (it is normal for the rinse water to show some discoloration!); close the tap.
7. Check the appliance and all hydraulic connections for leaks.

☑ *After the first regenerations of the appliance, some slight discoloration of the treated water might occur. This is totally harmless and will disappear rapidly!*

## BRINE CABINET/SALT TANK

1. Add water conditioner salt to the brine/salt tank.

## ELECTRONIC CONTROL PANEL

1. Program the electronic controller.

## ADJUSTMENT RESIDUAL HARDNESS

☑ *In practice the residual hardness is influenced by the inlet pressure, flow rate and hardness of the incoming untreated water. When adjusting the residual hardness, make sure these conditions are similar to the actual operating conditions.*

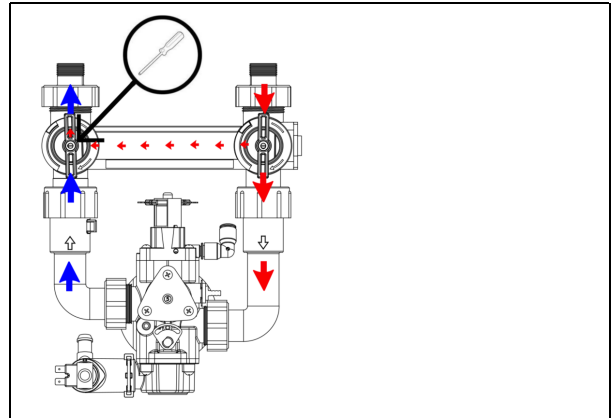

1. Adjust the residual hardness of the water that leaves the softener, by means of the adjusting screw, incorporated in the 'outlet' valve of the factory bypass:
  - to raise the residual hardness: turn the screw counter clockwise.
  - to reduce the residual hardness: turn the screw clockwise.
2. Measure the residual water hardness with a water hardness test kit; readjust if necessary.

## PERFORM REGENERATION

1. Manually initiate a regeneration, by pressing the **scroll** button repeatedly until the display shows:

**Regen in 10 sec**

2. Leave the appliance in this position; the countdown timer will countdown to 0 sec and start a regeneration.

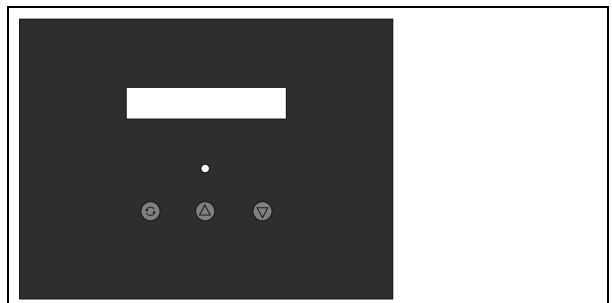

symbol	button	function
	SCROLL	to advance to the next parameter
	UP	to increase the value of the parameter
	DOWN	to decrease the value of the parameter

## ELECTRONIC CONTROL PANEL

### POWER-UP

After power-up the display will show the 5-digit Part Number of the electronic board and the installed software version.

### POWER FAILURE

In the event of a power failure, the program will remain stored in the NOVRAM® during an undefined period, while an incorporated SuperCap will maintain the correct time of day during a period of several hours; consequently, in case of prolonged power failure, the time of day might not be maintained; if this happens, the time of day will be reset to 8:00 when the power supply is re-established, while the indication will *flash*, indicating that the time of day needs to be set.

*When the power failure occurs during the execution of an automatic regeneration, the appliance will immediately return to the service mode; when the power supply is re-established, the appliance will resume the regeneration.*

### TIMER FAILURE

In the event of a timer failure, the display will show the message:

**Service Required**

The buzzer, if enabled (see Basic Settings), will beep continuously. If powering off/on the appliance doesn't solve this problem, professional service is required.

### MAINTENANCE REMINDER

Once the maintenance interval is reached, the following will happen:

1. the display will intermittently show the message:

**8:01      1000L –  
Maintenance Now**

2. the buzzer, if enabled (see Basic Settings), will beep 3 times every 5 minutes.

While the appliance will continue to operate normally, it is recommended to have preventive maintenance performed by a professional.

*To reset the maintenance reminder, simply access the configuration parameters programming mode.*

### SERVICE MODE

In **service mode** the display shows:

- on 1<sup>st</sup> line: the time of day and the remaining capacity;
- on 2<sup>nd</sup> line: alternately every 5 seconds:
  - the total volume of water used since commissioning;
  - the instantaneous flow rate;

**8:01      1000L –  
TotVol: 1234567L**

### REGENERATION MODE

In **regeneration mode** the display shows the actual regeneration cycle and, where relevant, the total remaining regeneration time and remaining cycle time:

**BRINE FILL**

**REGEN PENDING**

**Rgn:XXX CycY:ZZZ**

*The appliance can be reset to service mode at any time by pressing the **scroll** ⏪ button, as such manually advancing it through the regeneration cycles.*

### CHECKING THE FLOW METER

In case of water usage, the remaining capacity counter in the service display will count back per unit, i.e. per gallon. This way the correct functioning of the water meter can be verified.

### MANUAL REGENERATION

It is possible to manually initiate an immediate regeneration or a delayed regeneration (at the preprogrammed time of regeneration).

1. Press the **scroll** ⏪ button repeatedly until the display shows:

**Regen in 10 sec**

- If the control panel is left in this position, the countdown timer will countdown to 0 sec and *start an immediate regeneration*.
- To cancel this mode, press the **scroll** ⏪ button before the countdown timer has reached 0 sec; the display will show:

**Regen @      2:00**

- If the control panel is left in this position, a *delayed regeneration will be started* at the indicated preprogrammed time of regeneration.

## ELECTRONIC CONTROL PANEL

- To cancel this mode, press the **scroll**  button repeatedly; the control panel will return to the service mode.

### SALT LEVEL ALARM

The electronic control panel is equipped with a salt level alarm, that will periodically remind the user to check the salt level inside the brine/salt tank cabinet and to refill it with water conditioner salt if necessary. When the salt level alarm is triggered, the following will happen:

- the backlight of the display will flash on/off;
- the buzzer, if enabled (see Basic Settings), will beep 3 times every hour;
- the display will show:

**Check salt level  
To reset push** 

After refilling the brine cabinet, simply push the **down** button to reset the salt level alarm. If any other button is pushed, the salt level alarm will be cancelled, but not reset, meaning it will be activated again after the next regeneration!

If the brine/salt tank cabinet is refilled by the user with water conditioner salt, before the salt level alarm is activated, it is possible to reset the salt level alarm.

- Press the **scroll** button; the display will show:

**Salt Added?  
To reset push** 

- Press the **down**  button to *reset the salt level alarm*.

### HOLIDAY/V ACATION MODE

It is possible to put the appliance in holiday/vacation mode; this will prevent automatic regeneration from taking place, yet will ensure the appliance is automatically regenerated at the end of the holiday/vacation cycle.

- Press the **scroll**  button repeatedly until the display shows:

**Holiday: OFF**

- Press the **up** or **down** button to *activate the holiday/vacation mode by setting the number of full days away from home, or deactivate the holiday/vacation mode (OFF)*.

Once the control panel is back in service mode, the display will show:

**8:01 Holiday  
TotVol: 1234567L**

- The holiday/vacation mode is automatically canceled when a regeneration is manually initiated!*

### PROGRAMMING INSTRUCTIONS - BASIC SETTINGS

- Before entering the programming mode, make sure that the appliance is in service mode.*

- In case no button is pressed in a period of 5 min, the control panel will automatically return to the service mode; any changes made will NOT be saved!*

- Press the **scroll**  button and hold it for 2 sec until the display shows:

**Language: English**

- Press the **up**  or **down**  button to set the language.



- Press the **scroll** button again; the display will show:

**Set time: 8:01**

- Press the **up** or **down** button to set the time of day.

- Press the **scroll** button again; the display will show:

**HardUnit: gpg**

- Press the **up**  or **down**  button to set the unit of measure for water hardness. Make sure it is identical to the unit of measure of the water hardness test kit or water analysis report that is used to determine the hardness of the incoming untreated water!



- Press the **scroll**  button again; the display will show:

**Set hardn: XX gpg**

- Press the **up**  or **down**  button to set the hardness of the incoming untreated water.

- Press the **scroll**  button again; the display will show:

**Buzzer: 2**

- Press the **up**  or **down**  button to enable the buzzer by setting the sound level, or disable the buzzer (OFF).

- Press the **scroll**  button again; the display will show:

**Exit**

- Press the **up**  or **down**  button to save the settings into the NOVRAM® and exit the programming mode.



## ELECTRONIC CONTROL PANEL

### DIAGNOSTICS MODE

- ☑ *In the Diagnostics mode several operating parameters can be consulted; particularly during a service intervention, these parameters can be helpful to identify the cause of a problem or malfunction.*
- ☑ *Before entering the Diagnostics mode, make sure that the appliance is in service mode.*
- ☑ *In case no button is pressed in a period of 5 min, the control panel will automatically return to the service mode!*

#### ACCESSING THE DIAGNOSTICS MODE

1. Press the **scroll** ⤴ button and hold it for 6 sec until the display shows:

**System Check**

2. Within 10 sec, press the **down** ⬇ button; the display will show:

**Regen XXdays ago**

- You are now in the Diagnostics mode.
- Press the **scroll** ⤴ button to advance to the next diagnostics parameter.

#### AVAILABLE DIAGNOSTICS PARAMETERS

- **Regen X days ago**: number of days since last regeneration.
- **In Svc**: total number of days in service.
- **# of Regens**: number of regenerations since installation.
- **TotVol**: total volume of treated water since installation.
- **LastSet**: number of days since last change of configuration parameter or hardness of incoming untreated water.
- **InstFlow**: instantaneous flow rate through appliance.
- **AvgVol**: calculated average daily water usage.
- **LastRgn@**: consumed capacity at last regeneration.
- **Capacity**: calculated capacity between regenerations.
- **TotAgeCorr**: total accumulated age correction factor.
- **MaintCnt**: current status of maintenance reminder counter (counting up).
- **MP Resets**: number of resets of microprocessor.
- **Memory Reset**: number of corrupt memory start-ups.
- **CapToUse**: remaining capacity.
- **Fill**: length of refill cycle of last regeneration.
- **Alarm count**: current status of salt level alarm counter (counting up).
- **Reserve**: calculated reserve capacity.
- **EZ2L4d EZ2LPBr13**: software version.

#### EXITING THE DIAGNOSTICS MODE

1. Press the **scroll** ⤴ button repeatedly until the display shows:

**Exit**

- Press the **up** ⬆ or **down** ⬇ button to exit the Diagnostics mode.

# MAINTENANCE

## RECOMMENDATION

Notwithstanding the reliability of the appliance, we strongly recommend to have it serviced and maintained on a regular basis by a competent and duly trained technician. He will be able to determine the appropriate maintenance interval for the appliance, depending on your specific application and the local operating conditions. The advantages of performing regular maintenance are:

- regular check of the local operating conditions (water quality, pressure, etc);
- regular control and adjustment of the settings of the appliance, to guarantee it operates at maximum efficiency;
- minimize the risk of unexpected break-down.

Contact your dealer or installer for more information, or visit our website.

## ROUTINE CHECKS

Regularly the user should perform a basic check to verify if the appliance is functioning correctly, on the basis of the following control points:

1. Check settings of electronic control panel.
2. Measure water hardness before/after appliance.
3. Check drain line from control valve; there shouldn't be any water flow (unless appliance is in regeneration).
4. Check drain line from brine cabinet overflow; there shouldn't be any water flow.
5. Check appliance and surrounding area; there shouldn't be any water leakages.

## BYPASSING THE APPLIANCE

Occasionally it may be necessary to put the appliance hydraulically in bypass, i.e. to isolate it from the water distribution system; f.e.:

- in case of an urgent technical problem;
- when it is not necessary to supply treated water to the house/application (refill swimming pool, irrigation,...).

### WITH FACTORY BYPASS

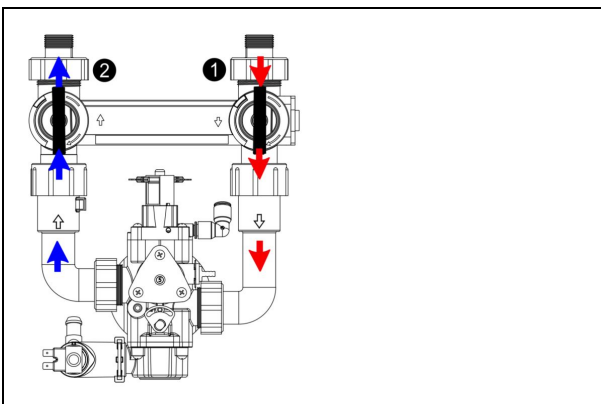

### SERVICE POSITION

- ① = inlet valve to appliance is OPEN
- ② = outlet valve from appliance is OPEN

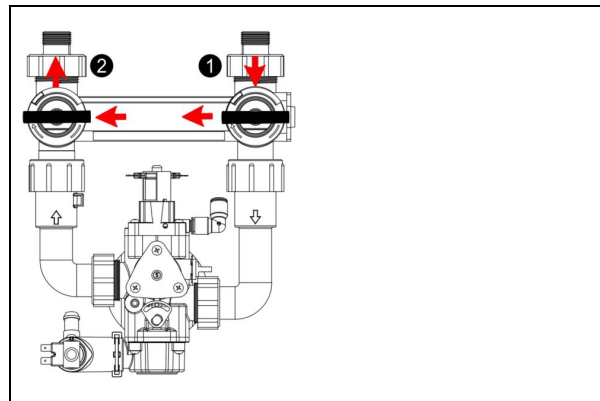

### BYPASS POSITION

- ① = inlet valve to appliance is CLOSED
- ② = outlet valve from appliance is CLOSED

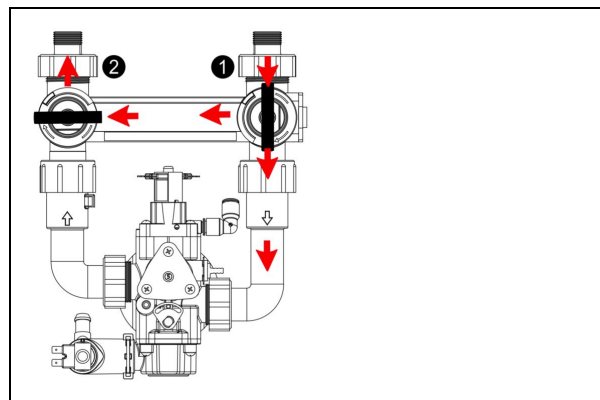

### MAINTENANCE/SOFT CHECK POSITION

- ① = inlet valve to appliance is OPEN
- ② = outlet valve from appliance is CLOSED

### WITH 3-VALVE BYPASS SYSTEM (not included)

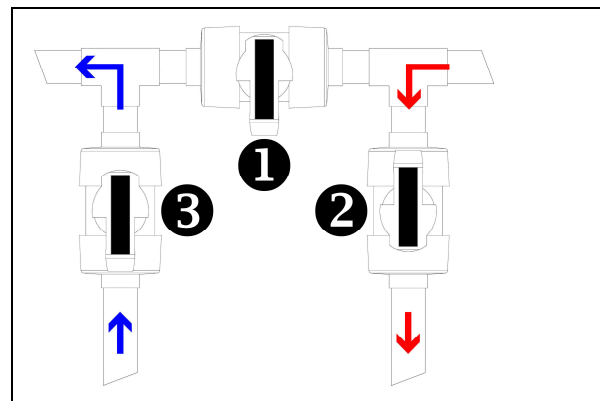

### SERVICE POSITION

- ① = bypass valve is CLOSED
- ② = inlet valve to appliance is OPEN
- ③ = outlet valve from appliance is OPEN

## MAINTENANCE

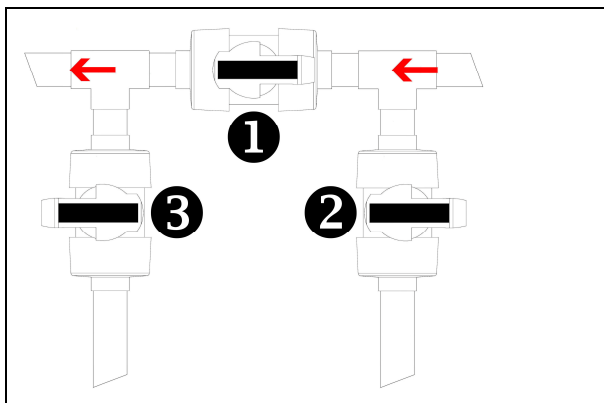

### BYPASS POSITION

- ❶ = bypass valve is OPEN
- ❷ = inlet valve to appliance is CLOSED
- ❸ = outlet valve from appliance is CLOSED

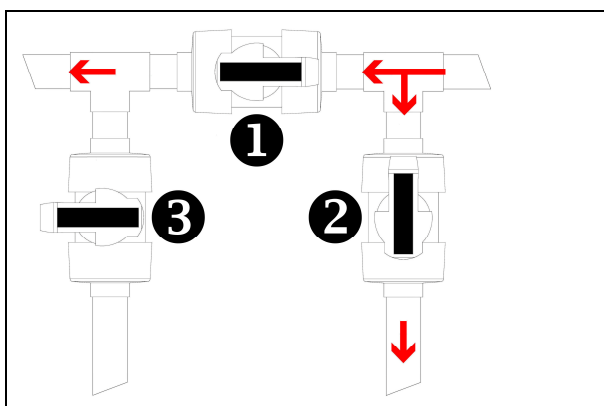

### MAINTENANCE/SOFT CHECK POSITION

- ❶ = bypass valve is OPEN
- ❷ = inlet valve to appliance is OPEN
- ❸ = outlet valve from appliance is CLOSED

### WATER CONDITIONER SALT

The appliance needs 'brine' for its periodic regenerations. This brine solution is made from water, that is automatically dosed in the brine/salt tank by the control valve, and water conditioner salt. The user should make sure that the brine/salt tank is always kept full of water conditioner salt. Therefore he should periodically check the salt level inside the brine/salt tank and refill it if necessary; the salt level alarm will remind him of this on a regular basis. The salt lid can be removed completely to facilitate refilling. The brine/salt tank is equipped with internal LED illumination; press any button on the control panel to activate it.

Ideally the level of water conditioner salt inside the brine cabinet is kept between 1/2 and full. A lower level of water conditioner salt can cause insufficient brine saturation, resulting in a loss of softening capacity. When you suspect salt bridging:

- Carefully pound on the outside of the brine cabinet to break loose the salt bridges.
- Pour warm water over the top of the salt to dissolve it.

### APPEARANCE

To retain the appearance of the appliance, simply wipe it with a damp cloth or clean it with a mild soap solution; never use abrasive cleaners, ammonia or solvents.

### RESIN CLEANER

Other contaminants (f.e. iron and other heavy metals) present in the feed water can cause the resin bed to foul up, resulting in a loss of softening capacity. An approved resin cleaner, such as PurGard, can be used periodically to thoroughly clean the resin bed.

### SANITIZING THE APPLIANCE

Every 6-12 months a certified technician should be requested to service, maintain, and perform a cleaning and disinfection on the equipment. This is recommended by the Water Quality Association and the Water Treatment Equipment Manufacturers.

This appliance is manufactured from premium quality material and assembled in safe conditions to assure it is clean and sanitary. If installed and serviced correctly, this appliance will not infect or contaminate your water supply. However, as in any 'device' plumbed-in in your water distribution system, a proliferation of bacteria is possible, especially in case of 'stagnant water'. Therefore this appliance is equipped with a 'days override' feature, that will automatically rinse the resin bed periodically, even in case of low or absence of water usage.

If the power supply to the appliance is disconnected for a longer period of time, we recommend, when the power supply is re-established, to manually initiate a complete regeneration.

# HYDRAULIC FLOW DIAGRAMS

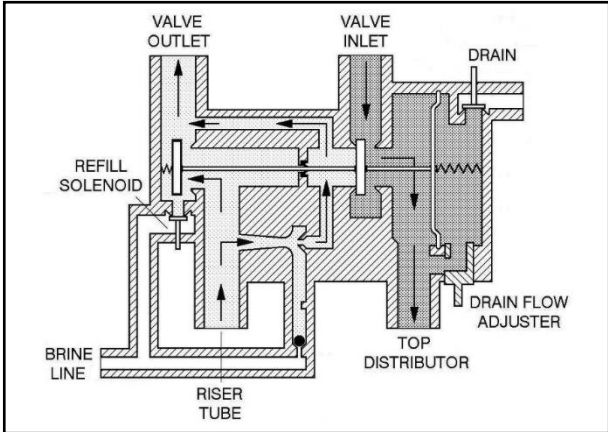
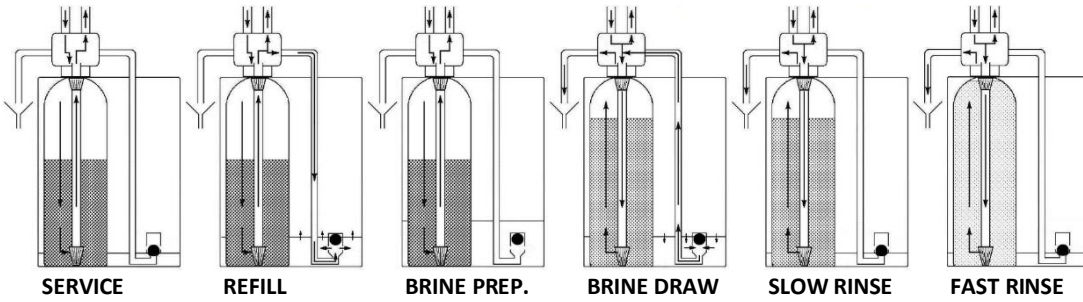

**SERVICE**

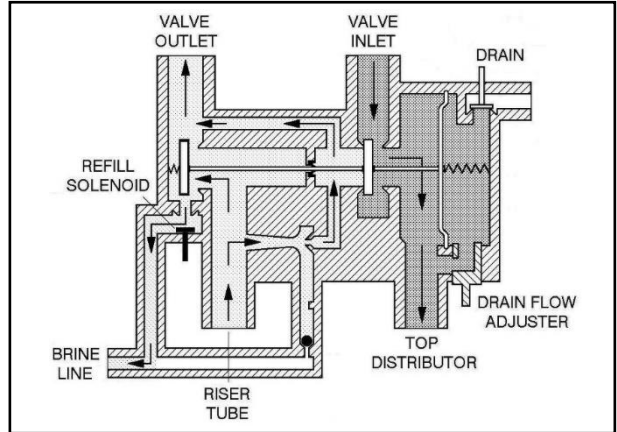

**REFILL**

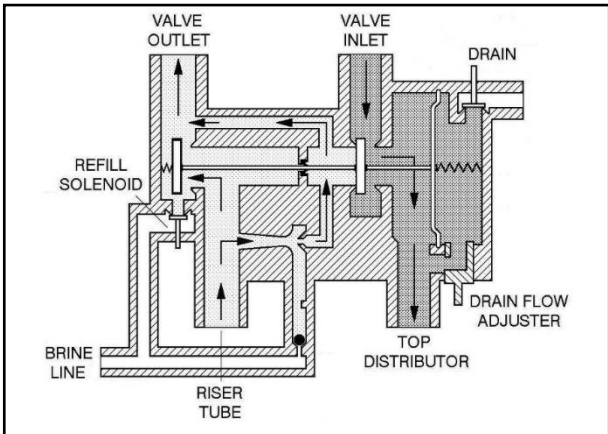

**BRINE PREPARATION**

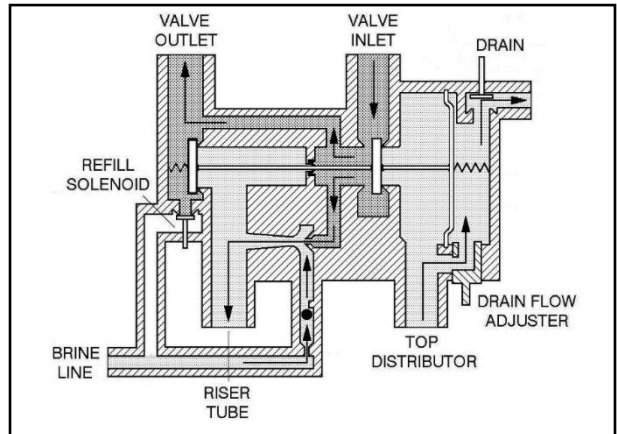

**BRINE DRAW / SLOW RINSE**

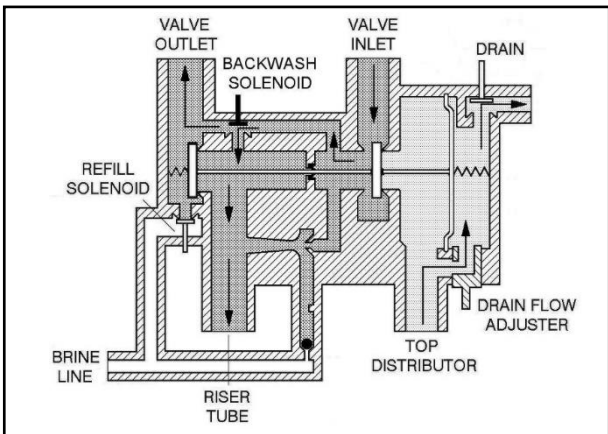

**FAST RINSE**

## TROUBLESHOOTING

PROBLEM	CAUSE	SOLUTION
<b>Hard (untreated) water to service</b>	Open or defective bypass	Close or replace bypass
	Appliance in regeneration	Wait until regeneration finishes or manually advance regeneration to end
	No salt in brine cabinet	Add salt and initiate regeneration manually
	Salt bridging	Break salt bridge(s) and initiate regeneration manually
	Change in raw water hardness	Measure the hardness of the incoming untreated water and adjust programming accordingly
	Appliance fails to regenerate	Refer to problem "Appliance fails to regenerate"
	Improper brine draw	Refer to problem "Improper brine draw"
	Decreasing exchange capacity of resin	Clean or replace resin bed
	Loss of resin	Refer to problem "Loss of resin"
Leak at riser tube	Verify that riser tube is seated correctly and is not cracked	
<b>Residual hardness in treated water</b>	Bypass not completely closed	Close bypass
	Appliance is overrunning its softening capacity	Measure the hardness of the incoming untreated water and adjust programming accordingly
		Verify operation of flow meter
<b>Appliance fails to regenerate</b>	Faulty electrical supply	Verify electrical service (fuse, transformer,...)
	Defective flow meter	Verify operation of flow meter
	Defective PCB	Replace PCB
	Defective drain solenoid	Replace drain solenoid
	Control valve does not switch to regeneration position	Check operating pressure; must be higher than 1,4 bar
<b>Appliance uses too much salt</b>	Excessive water in brine cabinet	Refer to problem "Excessive water in brine cabinet"
	System regenerates too frequently	Measure the hardness of the incoming untreated water and adjust programming accordingly
<b>Excessive water in brine cabinet</b>	Improper brine draw	Refer to problem "Improper brine draw"
	Improper setting of refill cycle	Verify setting of refill cycle
	Missing refill flow control	Verify that refill flow control is installed and properly sized
	Leak from control valve to brine cabinet	Clean or replace plunger and solenoid diaphragm of refill solenoid
		Check seal between brine draw check ball and brine draw restrictor
<b>Salt taste in treated water</b>	Improper setting of brine draw/slow rinse cycle	Verify setting of brine draw/slow rinse cycle
	Excessive water in brine tank	Refer to problem "Excessive water in brine tank"
	Improper brine draw	Refer to problem "Improper brine draw"
<b>Loss of water pressure</b>	Mineral or iron build-up in resin tank	Clean resin bed and control valve; increase regeneration frequency
	Plugged lower and/or upper distributor	Verify that distributors are free of debris
	Crushed lower and/or upper distributor	Replace distributor(s)
<b>Drain line from control valve flows continuously</b>	Appliance in regeneration	Wait until regeneration finishes or manually advance regeneration to end
	Drain solenoid stuck in open position	Clean drain solenoid
	Defective PCB	Replace PCB
<b>Drain line from brine cabinet overflow flows continuously</b>	Excessive water in brine cabinet	Refer to problem "Excessive water in brine cabinet"
	Leak between control valve and pressure tank	Verify seal between control valve and pressure tank
<b>Control valve fails to refill brine tank</b>	Improper setting of refill cycle	Verify setting of refill cycle
	Plugged refill flow control	Clean refill flow control
	Refill solenoid not opening	Verify operation of refill solenoid
<b>Loss of resin</b>	Lower and/or upper distributor damaged	Replace distributor(s)
	Leak between riser tube and upper distributor	Verify that riser tube is seated correctly and is not cracked

## TROUBLESHOOTING

PROBLEM	CAUSE	SOLUTION
Improper brine draw	Low operating pressure	Check operating pressure; must be higher than 1,4 bar
	Plugged injector and/or brine draw restrictor	Clean injector and/or brine draw restrictor
	Plugged injector filter	Clean injector filter
	Restricted drain line	Verify drain line for kinks or restrictions
	Restricted brine line	Verify brine line for kinks or restrictions
	Leak in brine line	Verify brine line and connections for air leakage
	No water in brine tank	Refer to problem "Control valve fails to refill brine tank"
	Fast rinse solenoid remains open	Verify operation of fast rinse solenoid

## ELECTRICAL WIRING DIAGRAM

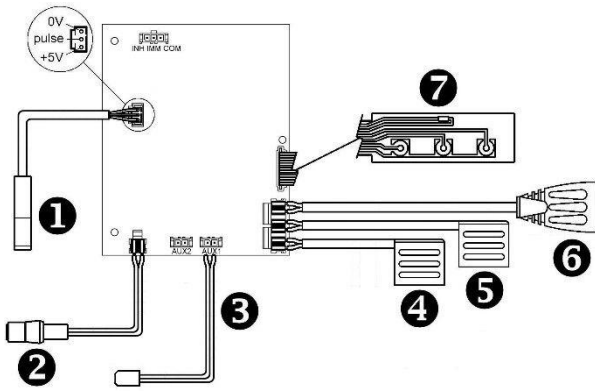

- ❶ = flow meter
- ❷ = power lead
- ❸ = auxiliary contacts (2 x 24 VDC, max. 500mA)
  - AUX1 = LED light brine cabinet
  - AUX2 = Function can be programmed
- ❹ = refill solenoid (marked 'RF')
- ❺ = backwash solenoid (marked 'BW')
- ❻ = drain solenoid
- ❼ = key pad

# EXPLODED VIEW - VALVE BODY ASSEMBLY

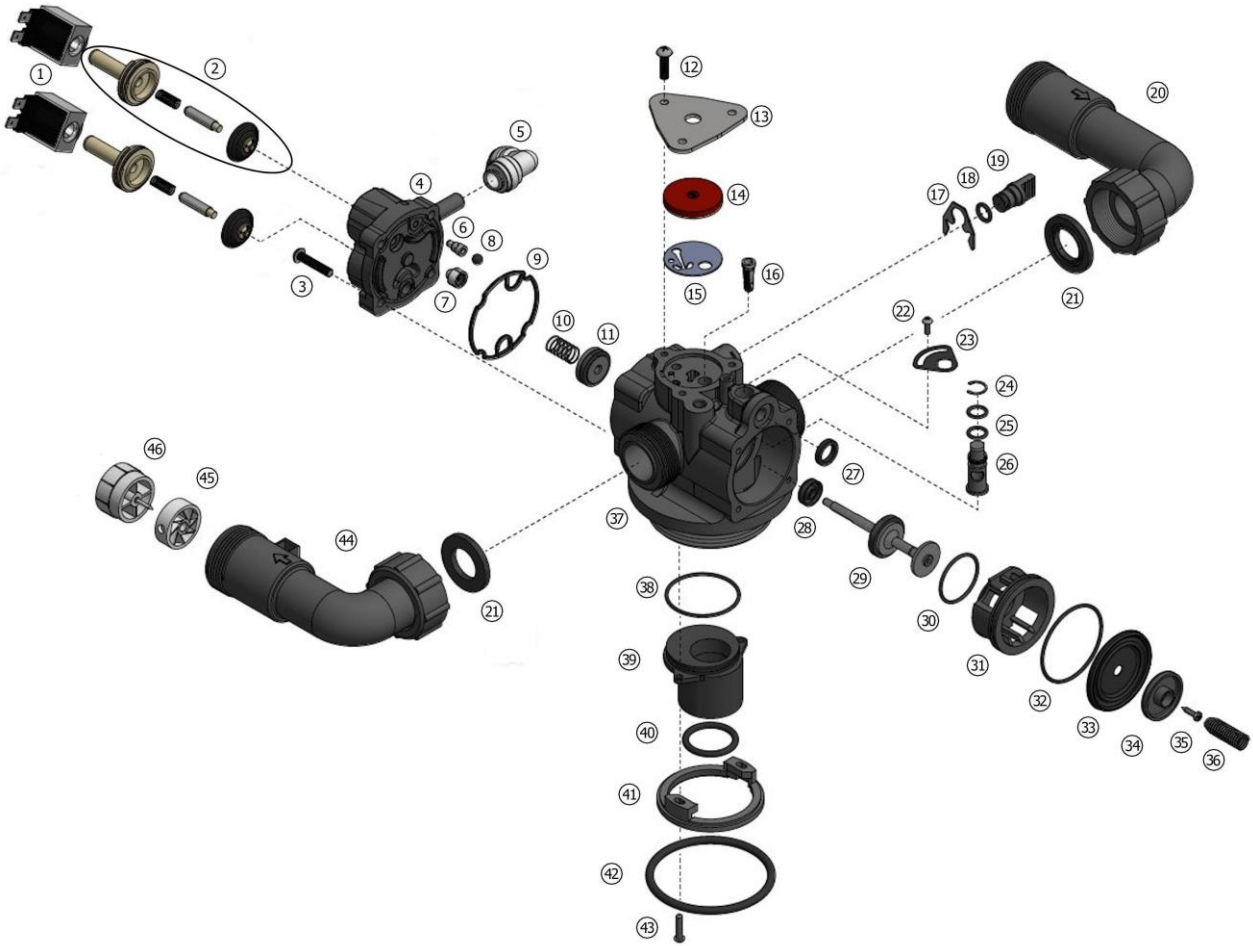



## EXPLODED VIEW - VALVE BODY ASSEMBLY

Item	PN	Description	Remark	(*)
1	74345	Solenoid coil		✓
2	74346	Solenoid assembly: <ul style="list-style-type: none"> <li>• Guide</li> <li>• Spring</li> <li>• Plunger</li> <li>• Diaphragm</li> </ul>	Only available as assembly	✓
3	15/222	Screw, back cap (4x)		✓
4	74306	Back cap		✓
5	74258	Brine elbow		
6	74015 74022	Brine draw restrictor 0,8 mm (white) Brine draw restrictor 1,0 mm (black)	9L 12L, 18L, 26L	
7	568/385/2/A	Refill flow control 0,25 gpm		
8	541/275	Check ball		✓
9	541/206	Gasket, back cap		
10	541/239	Spring, check disc	Incl. in repair kit A	
11	541/246	Check disc	Incl. in repair kit A	
12	15/89	Screw, cover plate (3x)		
13	541/221	Cover plate, injector		
14	428/5	Injector disc #5		✓
15	541/325	Gasket, injector		✓
16	74179	Filter, injector		✓
17	541/254	Spring clip		
18	186/118	O-ring, brine plug		
19	541/273	Brine plug		
20	72542	Elbow, inlet		
21	72467	Union gasket (2x)		
22	15/76	Screw, locking plate		
23	72609	Locking plate, drain flow adjuster		
24	19/19	Clip, drain flow adjuster		
25	186/134	O-ring, drain flow adjuster (2x)		
26	541/238	Drain flow adjuster		
27	529/244	O-ring, drain port		
28	467/216	Seal, body stem	Incl. in repair kit A	
29	72605	Body stem	Incl. in repair kit A, repair kit B	✓
30	185/024/1	O-ring, seat insert (small)	Incl. in repair kit A	
31	541/204	Seat insert	Incl. in repair kit A	✓
32	185/029/1	O-ring, seat insert (large)	Incl. in repair kit A	
33	72602	Main diaphragm	Incl. in repair kit A, repair kit B	✓
34	72507	Retainer, main diaphragm	Incl. in repair kit A, repair kit B	
35	72552	Screw, main diaphragm	Incl. in repair kit A, repair kit B	✓
36	516/221	Spring, main diaphragm	Incl. in repair kit A	
37	541/257/1	Valve body (incl. 467/216)		
38	185/029/1	O-ring, riser insert		
39	541/218	Riser insert 1,050"		
40	185/214/1	O-ring, riser tube		
41	541/232	Adapter ring		
42	185/67/4	O-ring, tank		
43	15/90	Screw, adapter ring (2x)		
44	72543	Elbow, outlet		
45	72544	Impeller		✓
46	72545	Hub, Impeller		
A	RK/541/244	Repair kit body stem and seat		✓
B	72611	Repair kit body stem		✓

(\*) Recommended Spare Part

## EXPLODED VIEW - VALVE HEAD ASSEMBLY

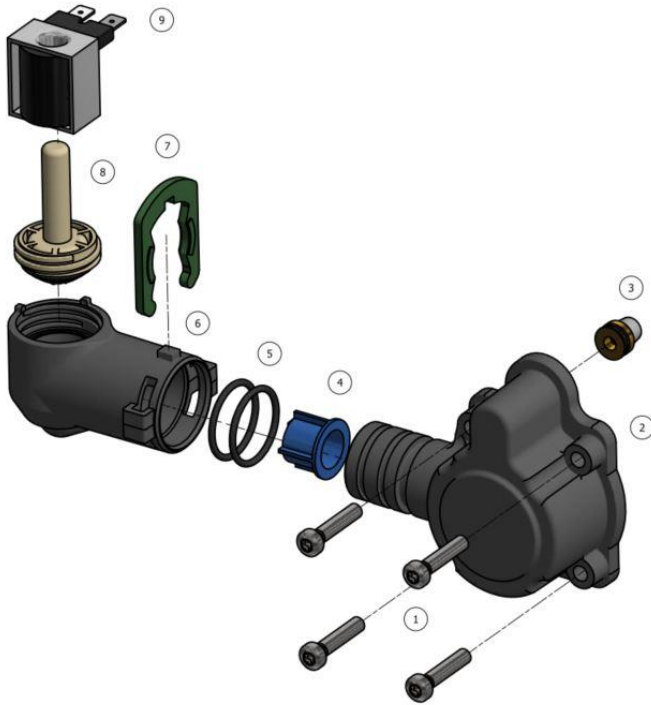

Item	PN	Description	Remark	(*)
1	15/222	Screw, valve head		
2	74375	Valve head		
3	541/300/J	Drain flow control 2,6 gpm		
4	74371	Filter, drain solenoid		
5	74364	O-ring, valve head (2x)		
6	74376	Holder, solenoid valve head		
7	74353	Clip, valve head		
8	74346	Solenoid assembly		✓
9	74345	Solenoid coil		✓

(\*) Recommended Spare Part

## TECHNICAL DATA

### Technical specifications:

Model	Spectrum Elite		
	1	1.5	2
Resin (ft <sup>3</sup> )			
Operating pressure min/max (psi)	20-120		
Operating temperature min/max (°F)	35-120		
Electrical connection	100-230/24VDC - 50/60Hz <sup>(1)</sup>		
Maximum power consumption (VA)	6,5		
Hydraulic connection inlet/outlet	3/4" or 1" Male		

(1) Supplied with 24VDC transformer

## STATEMENT OF LIMITED PRODUCT WARRANTY

### 1st year of ownership

This residential water system is warranted as to workmanship and material for a period of one year from date of original installation at the original installation site, if properly installed by an Intermountain Soft Water Certified Installer. Should any component in your system prove defective in the first year, it will be repaired, rebuilt or replaced at our option, provided it is returned directly to us.

After the 1st year of ownership, should any component in your system prove defective, it will be repaired, rebuilt or replaced at our option for a maximum charge of \$50.00, provided it is returned directly to us. Labor, transportation, shipping or other charges incurred in the diagnosis, replacement or repair of defective components are not covered by this warranty. If you choose not to send a defective component back to us, repairs to your system can be conducted in your home by a factory authorized service technician if your home is within the operating radius of an Intermountain authorized repair center. This warranty does not cover transportation, shipping, diagnosis, replacement and repair charges resulting from your in-home repair request. Intermountain Soft Water or its subsidiaries will not be held responsible for loss or damage caused by any defective component.

### Conditions

This warranty must be presented at time of claim and all claims must be presented within 30 days of occurrence. This warranty is void if your water system is not installed in compliance with prevailing plumbing codes, according to Intermountain Soft Water's installation protocol, or if the influent water temperature is hotter than 90oF or where the static water pressure is less than 40psi, or more than 80psi. Intentional/malicious damage, misuse, neglect, unauthorized modifications or accidental damage to the system is not covered by this warranty. This warranty does not cover damage caused by pressure surges, water hammer, power surges or sags, lightning, fire, flood, freezing, earthquake, acts of God or other casualty.

### Wear and Tear

Your water system is subject to normal wear and tear during its usable service life. Wear and tear is not regarded as a product defect and is not covered by this warranty. No Liability for Consequential Damages Unless otherwise required by applicable law, Intermountain Soft Water shall not be liable for any damages whatsoever (including without limitation, loss time, inconvenience, expenses such as telephone calls, labor or material charges incurred in connection with the removal or replacement of the part(s) or product(s), special, incidental, consequential, or indirect damages for personal injury, loss of business profits, business interruption, loss of business information, or any other pecuniary loss) arising out of the use of or inability to use the defective part(s) or product(s), even if Intermountain Soft Water has been advised of the possibility of such damages. Intermountain Soft Water's entire liability under any provision of this Limited Warranty shall be limited to the amount actually paid for the part(s) or product(s).

### No Other Warranties

Intermountain Soft Water specifically disclaims all other warranties, either express or implied, including, but not limited to implied warranties of merchantability and fitness for a particular purpose, with regard to the part(s), product(s) and/or any accompanying written materials. This limited warranty gives you specific legal rights. You may have other rights that vary from state/jurisdiction to state/jurisdiction.

### Pur-Gard

Your water system includes a Pur-gard/Pur-Gard Plus dispensing system. The Pur-gard/Pur-Gard Plus performance enhancing additive is essential to proper functioning of your system. If Pur-gard is not added to the dispensing system at the prescribed interval in your owner's manual, this warranty will be void.

In order for this limited lifetime warranty to be valid, you must:

– Be the original consumer purchaser, and have purchased the water equipment from Intermountain Soft Water, and

– Provide a copy of the original purchase receipt with proof of date and purchase price

This limited lifetime warranty is only valid if registered within 10 days of initial installation. If unregistered, this warranty is only valid for 1 year from the date of original manufacture.

Toll-free customer service: 1-800-454-3429



# SPECTRUM ELITE

## REPORTING BUGS

In the unlikely event of a bug:

- Collect the Serial Number and the unique PIN code of the appliance.
- Make a clear description of the problem, including screen shots if possible.
- Email it to the Technical Support department ([techsupportbelgium@eriewatertreatment.com](mailto:techsupportbelgium@eriewatertreatment.com)).

**FR** Français

**DE** Deutsch

**NL** Nederlands

**ES** Español

**IT** Italiano

**RO** Romana

**PL** Polski

**CZ** Český

**CN** 中文

**BG** Български език

**RU** Русский язык

Can be found on our website: <http://www.erie-igsoft.com/products/>

---

- **Wi-Fi network**

- Erie water treatment is not responsible for any network connection problems or any faults, malfunctions or errors caused by network connection.
- network connection may not work properly depending on the Internet provider.
- wireless network can experience interference from other devices with the same frequency.
- the surrounding wireless environment can make wireless network service run slowly.

## ELECTRONIC CONTROL PANEL



### PROGRAMMING INSTRUCTIONS - BASIC SETTINGS

Before entering the programming mode, make sure that the appliance is in service mode.

In case no button is pressed in a period of 5 min, the control panel will automatically return to the service mode; any changes made will NOT be saved!

1. Press the **scroll**  button and hold it for 2 sec until the display shows:

**Language : English**

- Press the **up**  or **down**  button to set the language.



2. Press the **scroll**  button again; the display will show:

**Set time: 8:01**

- Press the **up**  or **down**  button to set the time of day.

3. Press the **scroll**  button again; the display will show:

**HardUnit: °f**

- Press the **up**  or **down**  button to set the unit of measure for water hardness. Make sure it is identical to the unit of measure of the water hardness test kit or water analysis report that is used to determine the hardness of the incoming untreated water!



4. Press the **scroll**  button again; the display will show:

**Set hardn: XX °f**

- Press the **up**  or **down**  button to set the hardness of the incoming untreated water.

5. Press the **scroll**  button again; the display will show:

**Buzzer: 2**

- Press the **up**  or **down**  button to enable the buzzer by setting the sound level, or disable the buzzer (OFF).



6. Press the **scroll**  button again; the display will show:

**Pin: 1234**

- This is the unique PIN for the Wi-Fi configuration of your appliance.

7. Press the **scroll**  button again; the display will show:

**Wifi: Configure**

- Press the **up**  or **down**  button to set the desired Wi-Fi mode:
  - **CONFIGURE**: to configure the Wi-Fi settings via Wi-Fi direct mode.
  - **ON**: Wi-Fi activated.
  - **OFF**: Wi-Fi deactivated.

8. Press the **scroll**  button again; the display will show:

**Exit**

- Press the **up**  or **down**  button to save the settings into the NOVRAM® and exit the programming mode.

# ERIE CONNECT™ APP

## APP INSTALLATION

Download the Erie connect™ app to your mobile device from the Apple App Store or Google Play Store and open the application.

## SELECT YOUR LANGUAGE



- Select one of the available languages to continue.

## SELECT THE REGION OF YOUR APPLIANCE



- Select your region “Global” or “China”.

## APP START-UP

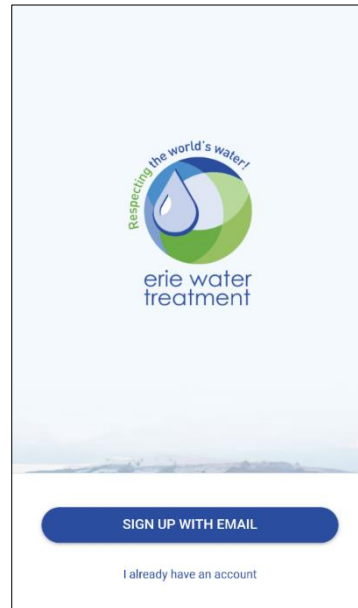

- **SIGN UP WITH EMAIL:** if you don't have a user account yet, you must first register a new user account based on your email address.
- **I already have an account:** sign in with your existing user account.

## SIGN UP WITH EMAIL

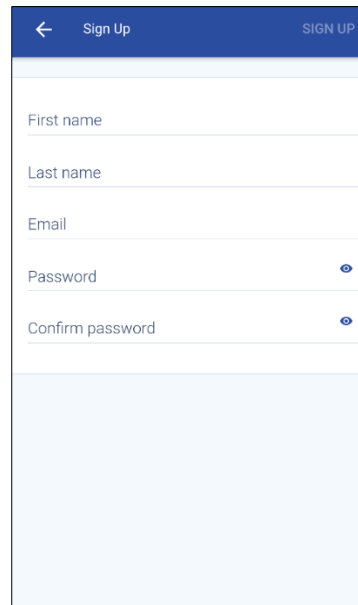

- Fill in the requested information.
- Press “SIGN UP”.
- Press “ACCEPT” to accept the terms & conditions:



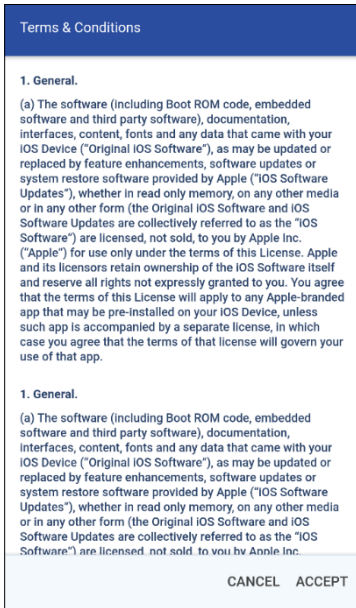

- **1<sup>st</sup> approval:** User account, usage of personal settings.
- **2<sup>nd</sup> approval:** Appliance information, data usage of the appliance.
- You will get the message **“Confirmation mail has been sent. Please check your inbox.”**
- Check your mailbox and confirm the activation of your account to finalize the registration process.

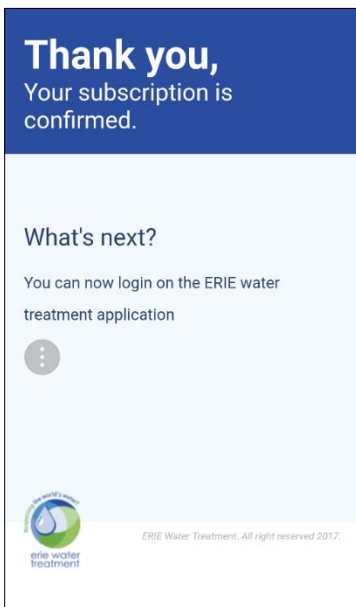

## I ALREADY HAVE AN ACCOUNT

- Return to the app and sign in to your account by filling in your email address and password.

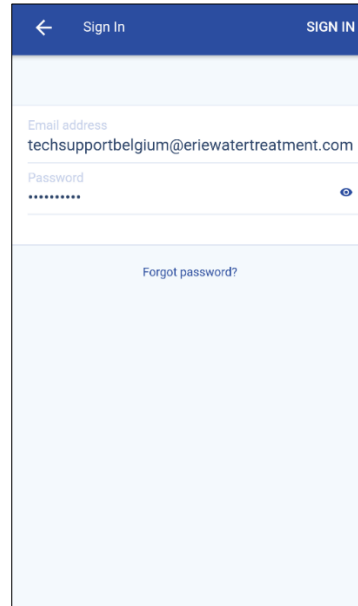

- Press **“SIGN IN”** or **“Forgot password?”**.

## FORGOT PASSWORD

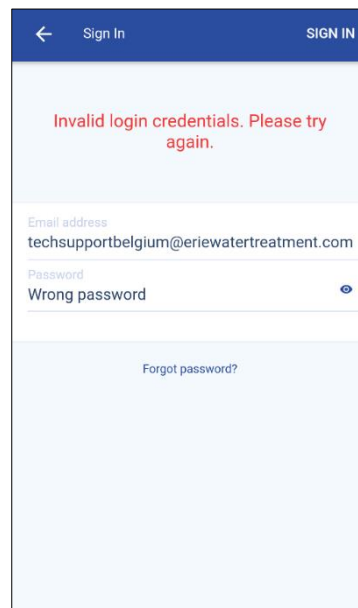

**Note:** This is what you will see if you enter the wrong credentials.

- Press **“Forgot password?”** if you want to reset the password for your user account.
- Fill in your email and press **“Reset”**.
- You will get the message **“A mail with further instructions has been sent. Please check your inbox.”**

- Check your mailbox and follow the instructions.

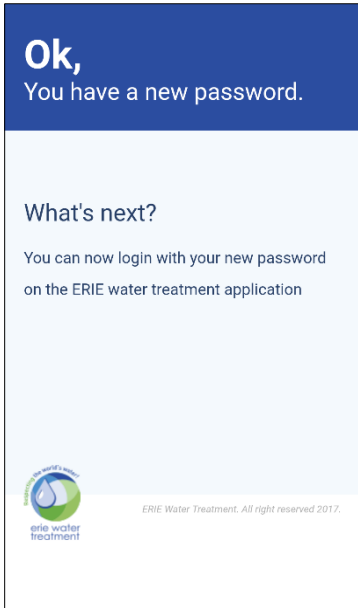

## SETTING UP AN APPLIANCE

*Make sure that the mobile device is in the vicinity of the appliance to enable a Wi-Fi direct connection between the mobile device and the appliance!*

After signing in you will be asked to add a first appliance:

- Press “+”.

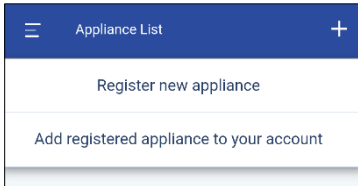

- **Register new appliance:** to set up a new appliance for the first time by connecting it to your Wi-Fi network.
- **Add registered appliance to your account:** to add an existing and already registered appliance, to your account.

## REGISTER NEW APPLIANCE

### Step 1:

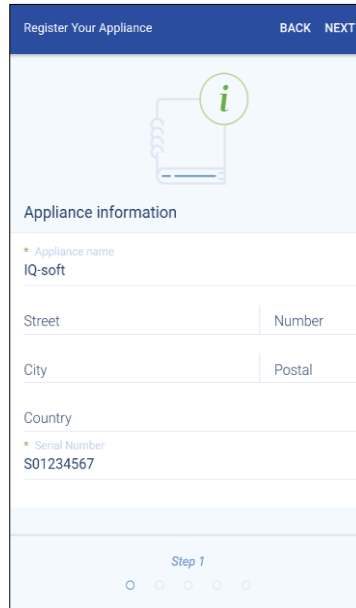

- Enter information about the appliance.
- Press “NEXT”.

Only the name (can be anything and can easily be changed afterwards) and the Serial Number are required. The Serial Number can be found on the Product ID label of the appliance and is unique for your appliance.

### Step 2:

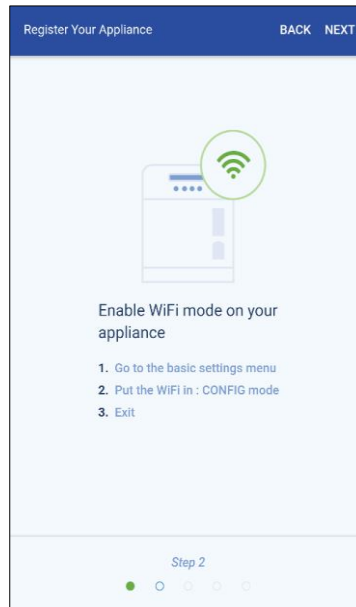

- Make sure the Wi-Fi mode on the appliance is set to CONFIGURE mode.
- Press “NEXT”.

At first start-up, the appliance will automatically be in CONFIGURE mode. To manually set the Wi-Fi mode on the appliance to CONFIGURE mode, see section Electronic Control Panel.

**Step 3:**

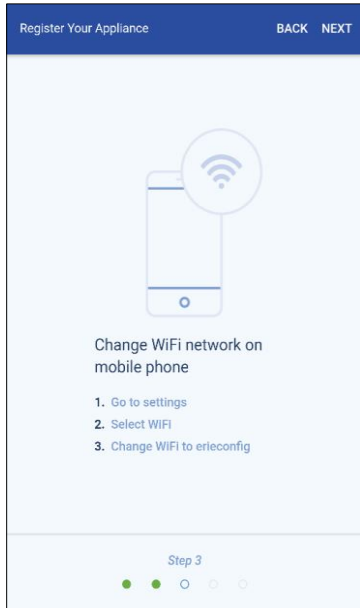

- Switch the Wi-Fi on the mobile device to the **erieconfig** network to establish a Wi-Fi direct connection between the mobile device and the appliance.
- Once the mobile device is connected to the **erieconfig** network, switch back to the app and press **“NEXT”**.

**Step 4:**

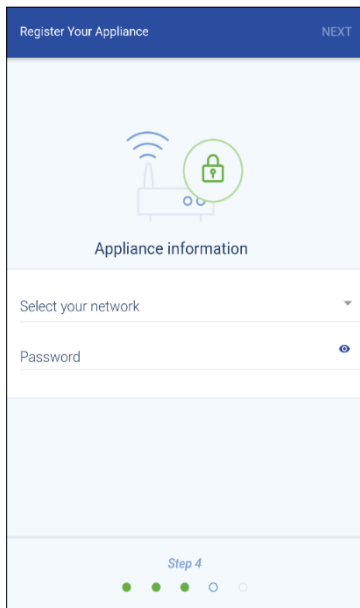

- Select the Wi-Fi network, to which you want to connect the appliance.
- Enter the Wi-Fi network password.
- Press **“Next”**.

Make sure to enter the correct Wi-Fi network password. Press **“👁️”** to make the password visible. The device cannot connect to the network when an incorrect password has been entered. In such case the appliance will never come online.

**Step 5:**

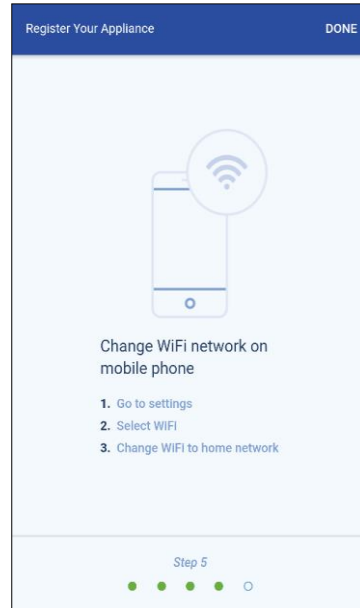

- Switch the Wi-Fi on the mobile device back to your usual Wi-Fi network (Wi-Fi or LTE data).
- Press **“DONE”**.
- The appliance will automatically connect to the selected Wi-Fi network. Check the Wi-Fi status on your appliance, which is shown on the second line of the display :
  - **CONNECTED**: appliance connected to Wi-Fi Wi-Fi network.
  - **NO INTERNET**: appliance connected to Wi-Fi Wi-Fi network, but no internet connection available.
  - **PASSWORD ERROR**: appliance not connected to Wi-Fi network.
  - **CONFIGURE**: no Wi-Fi connection, Wi-Fi mode set to configure via Wi-Fi direct mode.
  - **OFF**: Wi-Fi deactivated.

Most recent phones will automatically reconnect to the previous Wi-Fi network, when the Wi-Fi direct network **erieconfig** is deactivated automatically by the appliance. You may have to wait for 10 to 20 sec for your phone to do this step for you.

Make sure that you are not connected to the **erieconfig** network when you press **“DONE”**.

- The Wi-Fi connection of your appliance is now configured. The appliance will automatically be registered into the database and will show up in your appliance list after a few minutes.

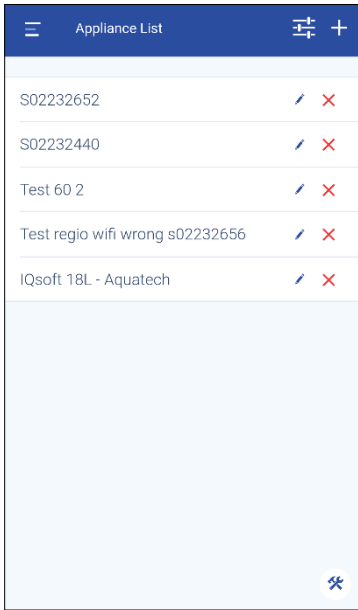

If the appliance is not online within a couple of minutes please follow the instructions on the screen. Most likely the Wi-Fi password has been entered incorrectly. Repeat the REGISTER NEW APPLIANCE process to fix this; first remove the appliance and afterwards repeat the procedure "Register new appliance".

## ADD REGISTERED APPLIANCE TO YOUR ACCOUNT

- Use the following procedure to add an existing and already registered appliance to your user account. You'll need the PIN-code and Serial Number of the appliance you want to add.
- The PIN-code of the appliance can be found in the basic settings. It is also displayed when plugging-in the power supply (after the firmware description).
- The Serial Number can be found on the Product ID label on the appliance.
- You can add multiple appliances to your user account.

### Step 1:

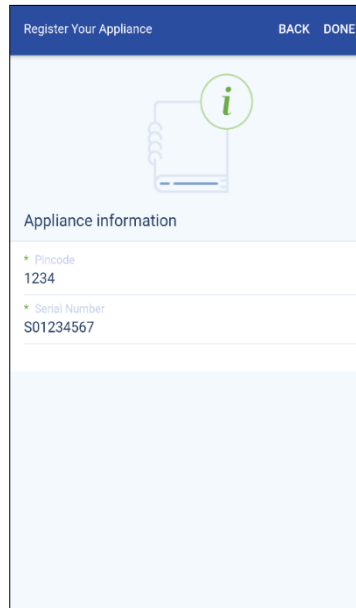

- Fill in the PIN-code and Serial Number of the appliance that you want to add to your user account.
- Press "**DONE**". If correct, the appliance will show up in your appliance list.

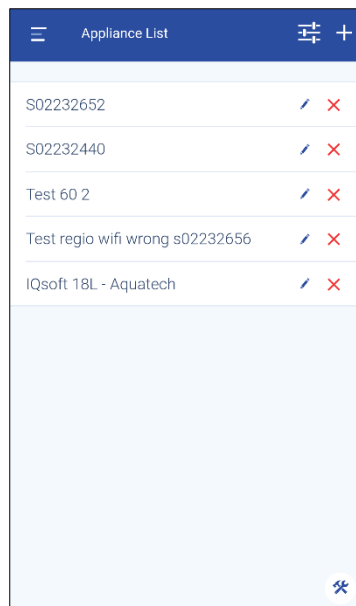

## DASHBOARD

- Press “☰” to switch to the main menu.

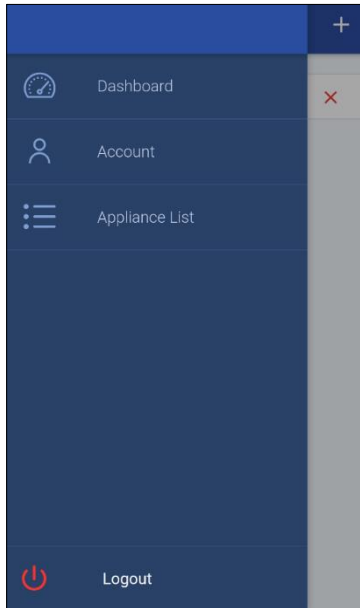

- Press “Dashboard”. You will see the Dashboard showing the status of the selected appliance.
- Appliance ‘In Service’:

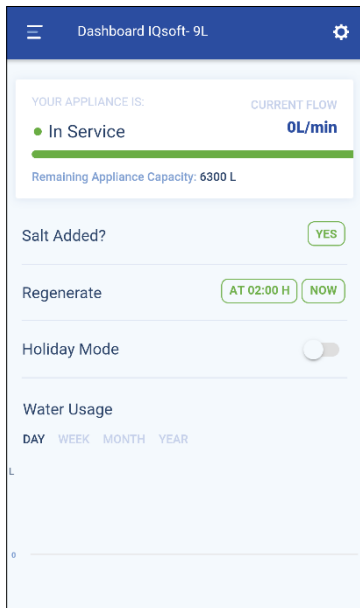

- You can:
- see the current flow rate and remaining capacity,
  - reset the salt level alarm,
  - start a regeneration (delayed or immediate),
  - activate and set the holiday mode,
  - see the water usage.

- Appliance ‘Regenerating’:

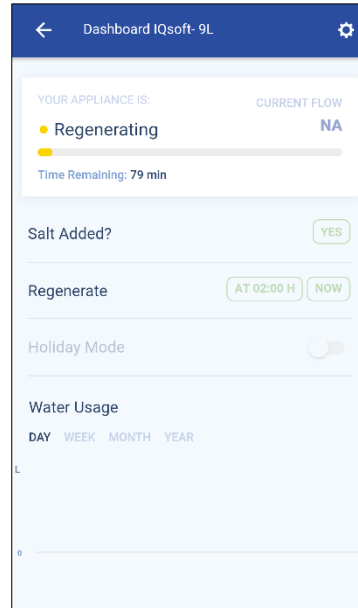

- You can see the remaining regeneration time.

- Appliance ‘In Holiday’:

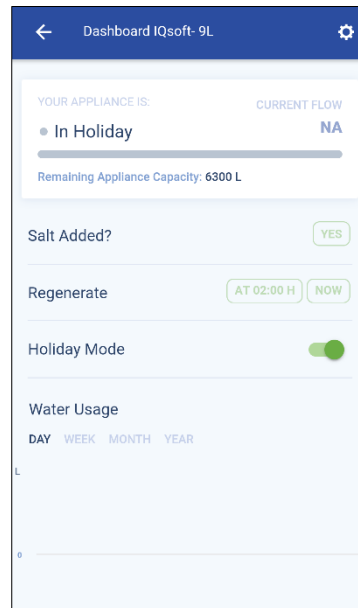

- To put the appliance in holiday mode:
- activate the slider,
  - set the date of return.

- Appliance 'offline':

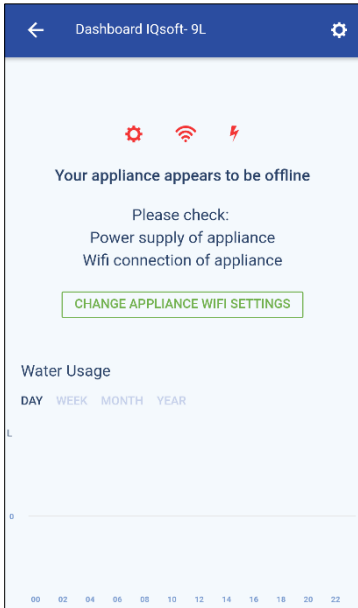

- Appliance in 'Maintenance required' mode:

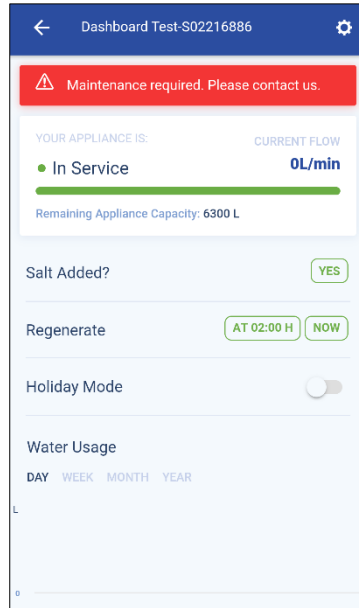

- Appliance in 'Salt level low' mode:

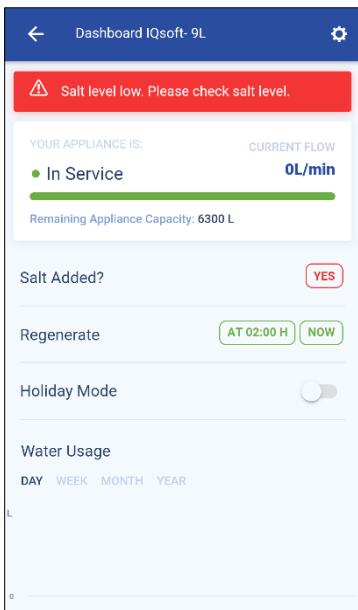

# ERIE CONNECT™ APP

## USER ACCOUNT

- Press “☰” to switch to the main menu.

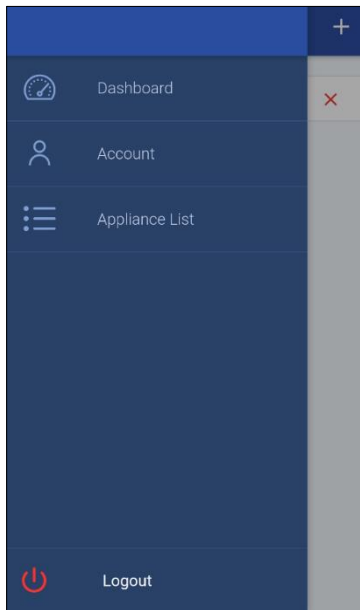

## APPLIANCE LIST

- Press “☰” to switch to the main menu.

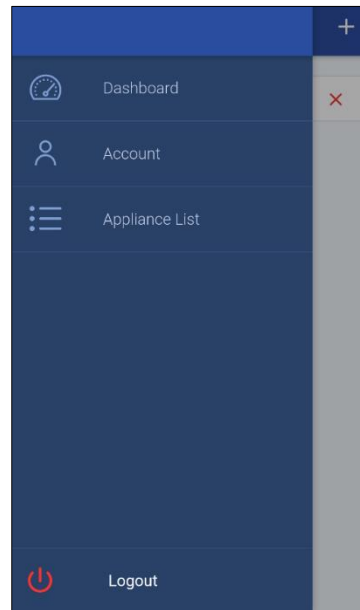

- Press “Account”. You will see the information of your user account:

A screenshot of the 'Account' page in the ERIE CONNECT app. The page has a blue header with 'Account' and 'UPDATE' text. Below the header is a profile card for 'Sofie Redig' with a water drop icon. Underneath are form fields for 'First name' (Sofie), 'Last name' (Redig), 'Password' (with a 'Change' link), 'Street' and 'Number', 'City' and 'Postal', and 'Country'.

- Press “Appliance List”. You will see the appliance list with all added registered appliances on your account:

A screenshot of the 'Appliance List' page in the ERIE CONNECT app. The page has a blue header with 'Appliance List' and a plus sign. Below the header is a list of appliances, each with a unique ID and edit/delete icons. The appliances listed are: S02232652, S02232440, Test 60 2, Test regio wifi wrong s02232656, and IQsoft 18L - Aquatech. A blue plus icon is in the bottom right corner.

- Press “⌵” and select how to sort your appliances.

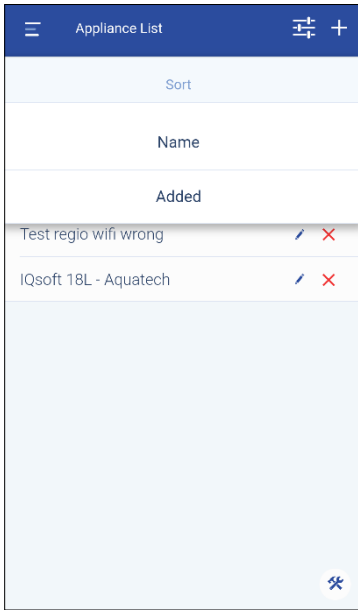

- Select sort by “Name”, listed alphabetically or by “Added”, listed on adding date.

## APPLIANCE SETTINGS

- While in the appliance dashboard screen, press “⚙️” and press “SETTINGS”.

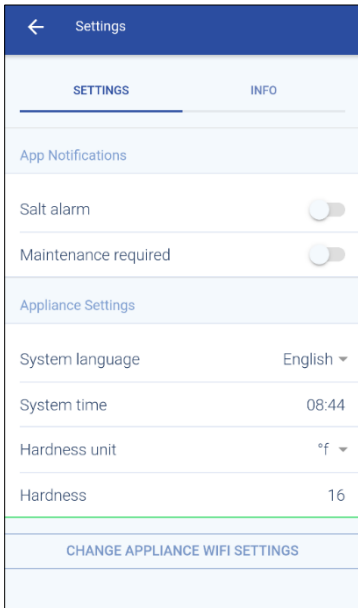

- If you activate App Notifications, you will get the following Push-message to your mobile device:

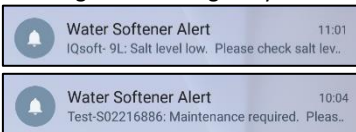

- You can change the basic Appliance Settings.

## APPLIANCE INFO

- While in the appliance dashboard screen, press “⚙️” and press “INFO”.

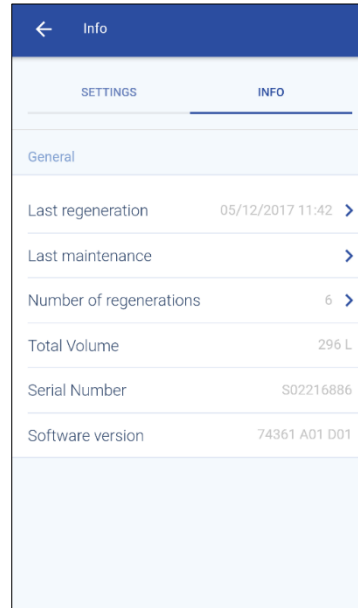

- You can consult historic data of the appliance.
- Press “>” to get more information about a specific item.





erie water treatment

a division of **Aquion, Inc.**

[www.eriewatertreatment.com](http://www.eriewatertreatment.com)